

# Counter Height Storage Cabinets – 9000 Series Assembly Instructions

Thank you for selecting Salsbury's counter height storage cabinet. We are confident that the quality and construction of the cabinet will prove to be a good investment. Individual job conditions will dictate whether the storage cabinets should be anchored to the wall, the floor, or both and the type of fasteners that are to be used to do so.

## General Notes

1. These instructions represent the assembly of the Salsbury standard 18" deep counter height storage cabinets. Parts and quantities of fasteners used will be different than for the other standard cabinets.
2. All connections using screws should initially be just finger tight. Square the cabinet assembly before firmly tightening all connections.

## STEP 1

Locate the left and right back panels and lay them down on a flat surface with the flanges facing up. Place the left back panel on top of the right back panel and slide the latches in place to secure together. The end with four (4) latches along the edge is the bottom end.

See Figure 1.

Figure 1

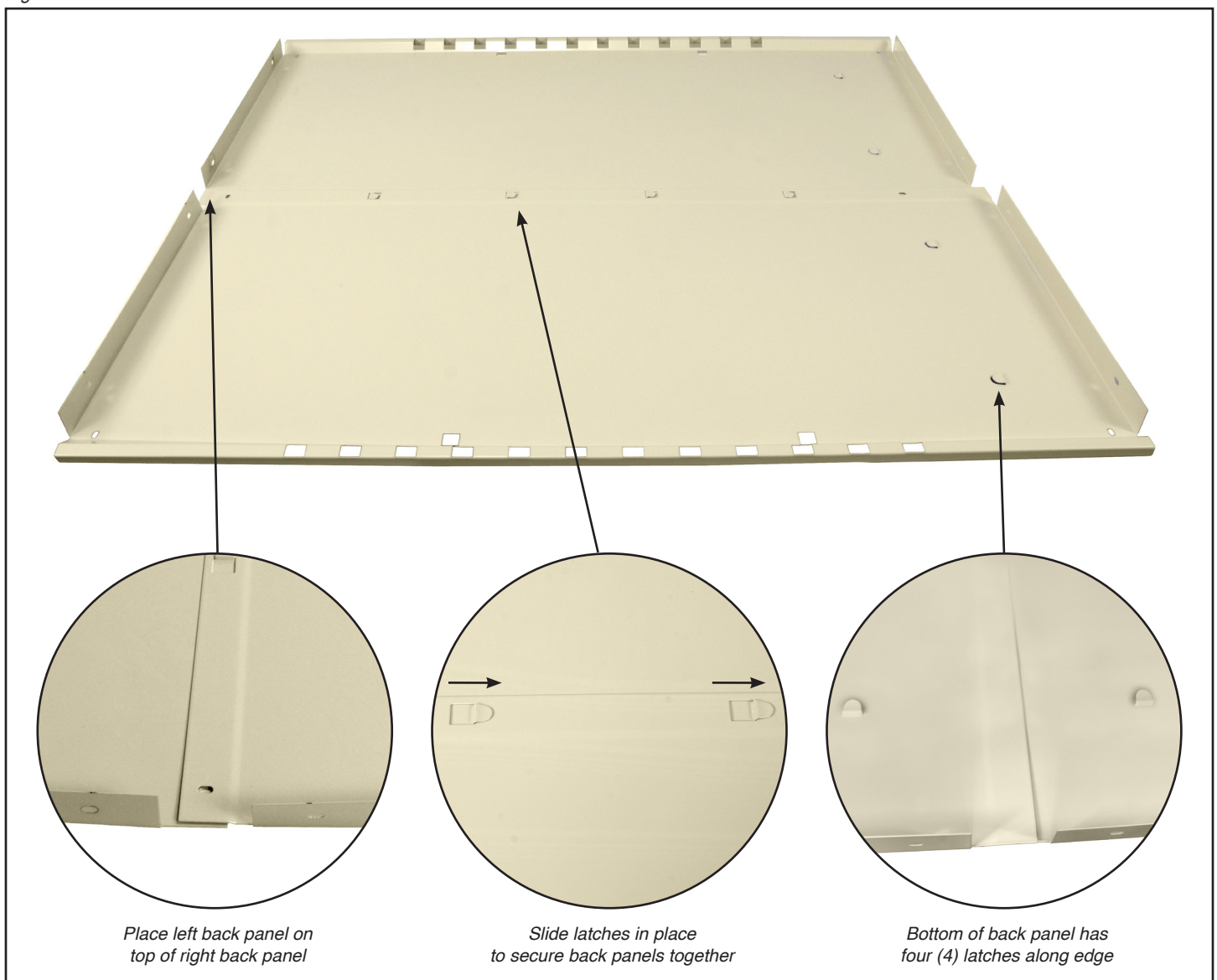

## SALSBURY INDUSTRIES

1010 East 62nd Street, Los Angeles, CA 90001-1598  
Phone: 1-800-562-5377 Int'l Phone: 323-846-6700 Fax: 1-800-562-5399 Int'l Fax: 323-846-6800  
[www.lockers.com](http://www.lockers.com) [engineering@lockers.com](mailto:engineering@lockers.com)

Installation instructions are provided as general guidelines. It is advised that a professional installer be consulted. Salsbury Industries assumes no product assembly or installation liability. Copyright © 2016 Salsbury Industries. All rights reserved. (6/28/2016)

**STEP 2**

Locate the right side panel. Attach the right side panel to the back panel by inserting the two (2) latches on the side panel through the slots on the back panel. See Figure 2.

Figure 2

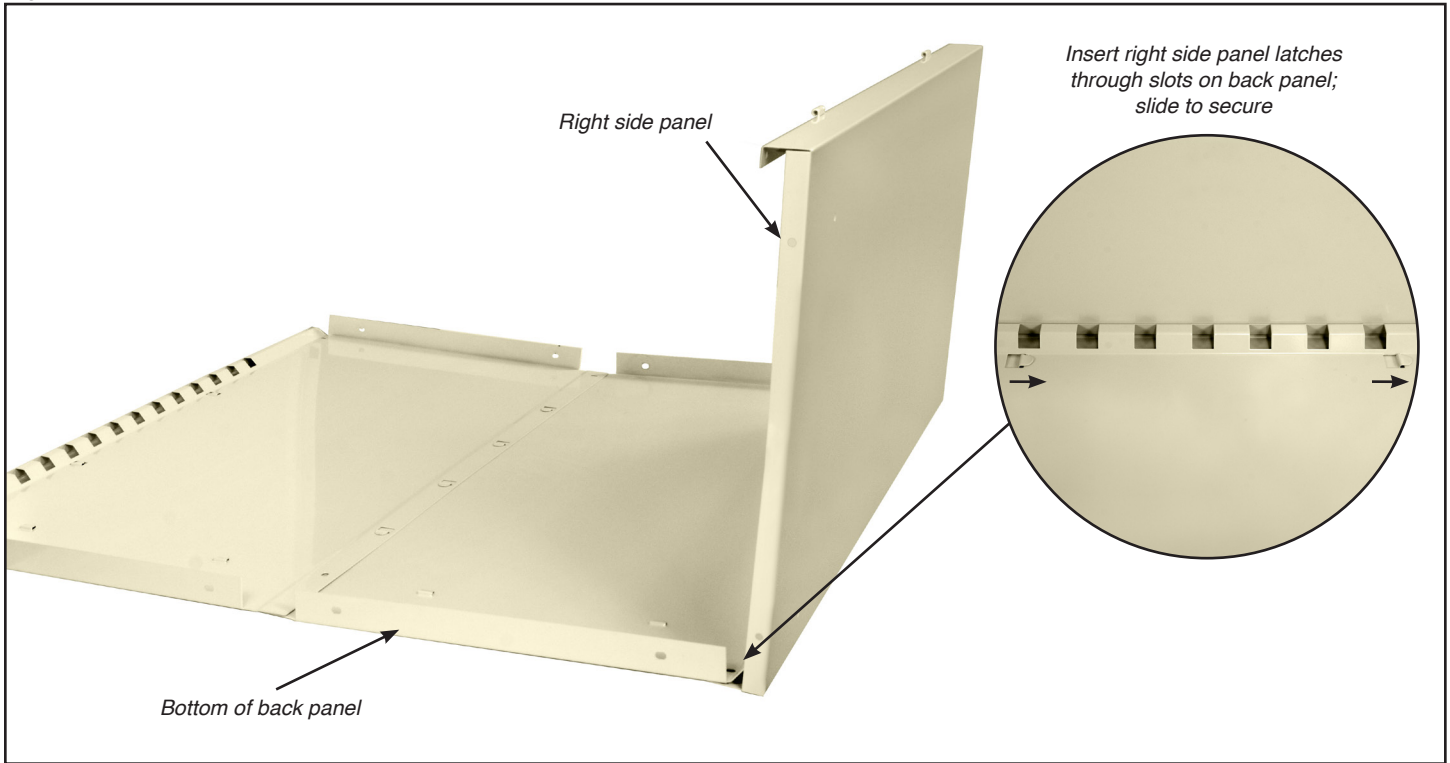

**STEP 3**

Locate the left side panel and repeat step 2. See Figure 3.

Figure 3

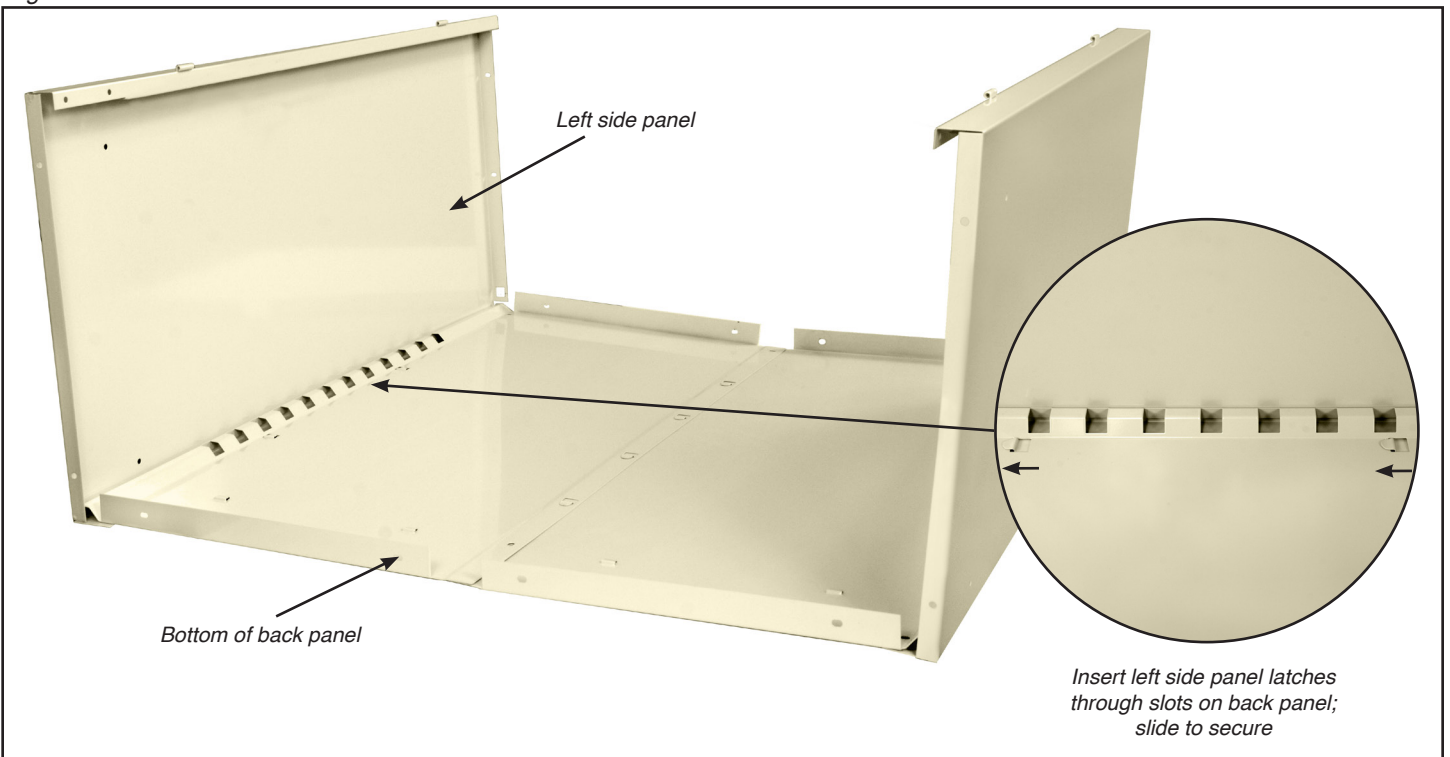

**SALSBURY INDUSTRIES**

Phone: 1-800-562-5377      1010 East 62nd Street, Los Angeles, CA 90001-1598      Int'l Phone: 323-846-6700      Fax: 1-800-562-5399      Int'l Fax: 323-846-6800  
[www.lockers.com](http://www.lockers.com)      [engineering@lockers.com](mailto:engineering@lockers.com)

**STEP 4**

Locate and secure the top panel by placing the flange on the back of the top panel behind the back panel. Simultaneously inserting the top panel latches through the slots on both side panels. Attach top panel to back panel and side panels with screws and nuts (provided) with nuts on the inside of the unit. See Figure 4.

Figure 4

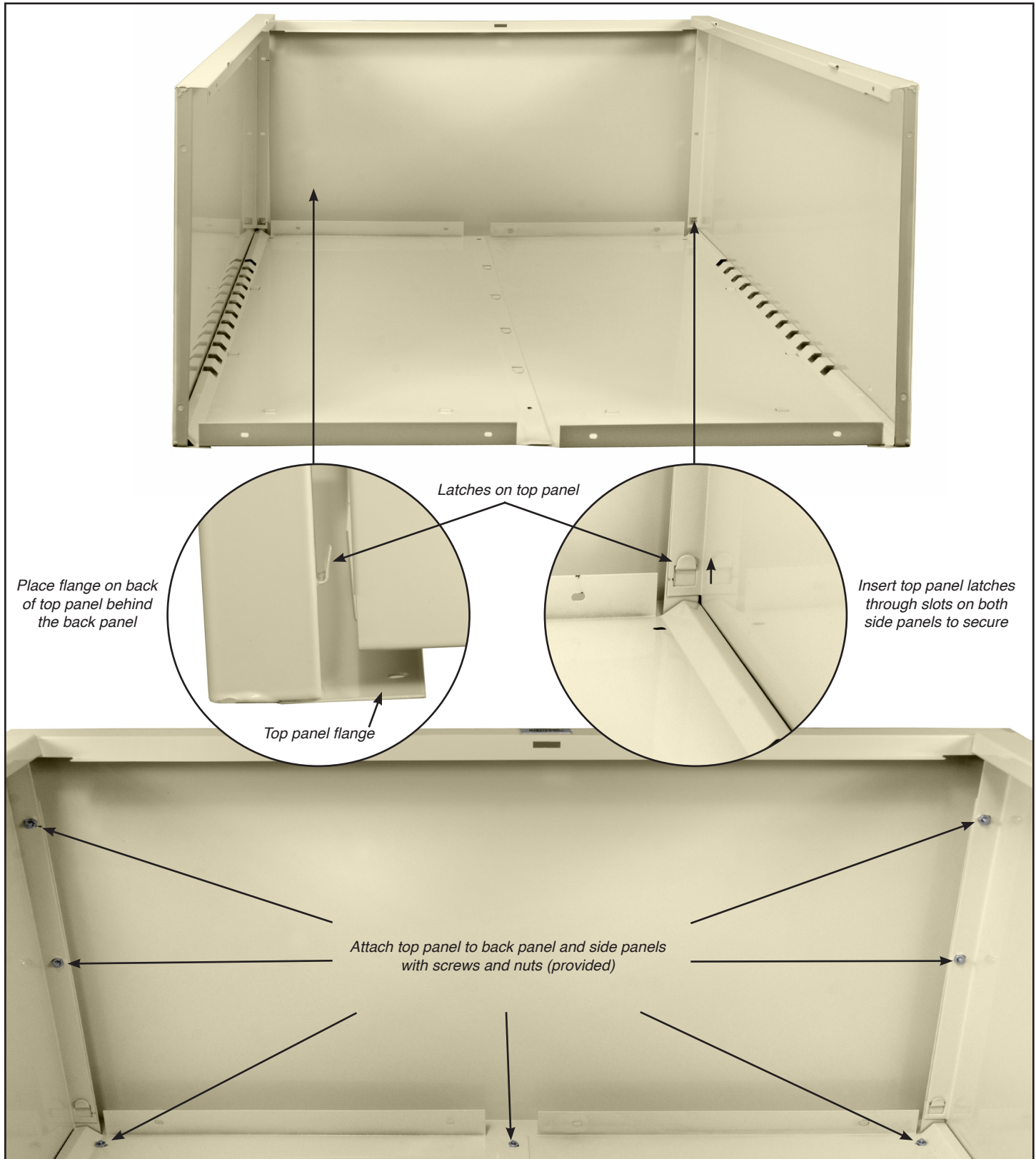

**SALSBURY INDUSTRIES**

Phone: 1-800-562-5377      1010 East 62nd Street, Los Angeles, CA 90001-1598      Int'l Phone: 323-846-6700      Fax: 1-800-562-5399      Int'l Fax: 323-846-6800  
[www.lockers.com](http://www.lockers.com)      [engineering@lockers.com](mailto:engineering@lockers.com)

**STEP 5**

Locate the bottom panel and insert the bottom panel's back flange into the latches located on the back panel. See Figure 5A. Attach bottom panel to back panel and side panels with screws and nuts (provided) with nuts on the inside of the unit. See Figure 5B.

Figure 5A

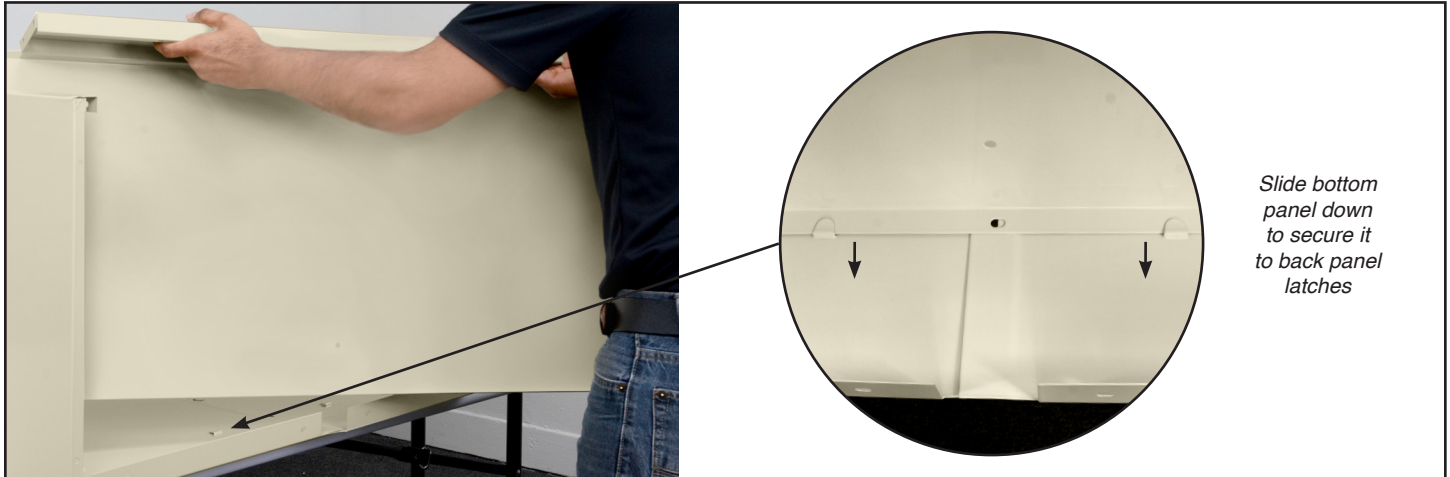
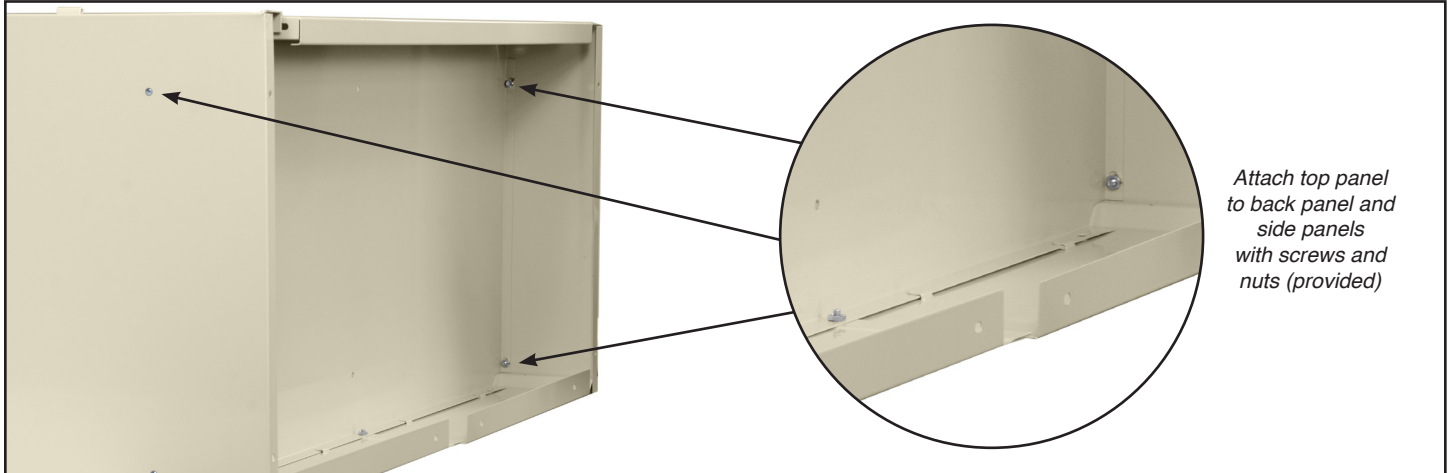

Figure 5B



**STEP 6**

Place the first adjustable shelf into the unit by inserting the shelf panel into the desired shelf notch height located on the back panel. Then insert shelf clips into the front interior flanges of both side panels to support the front of the shelf. Repeat this process for the remaining shelves. See Figure 6.

Figure 6

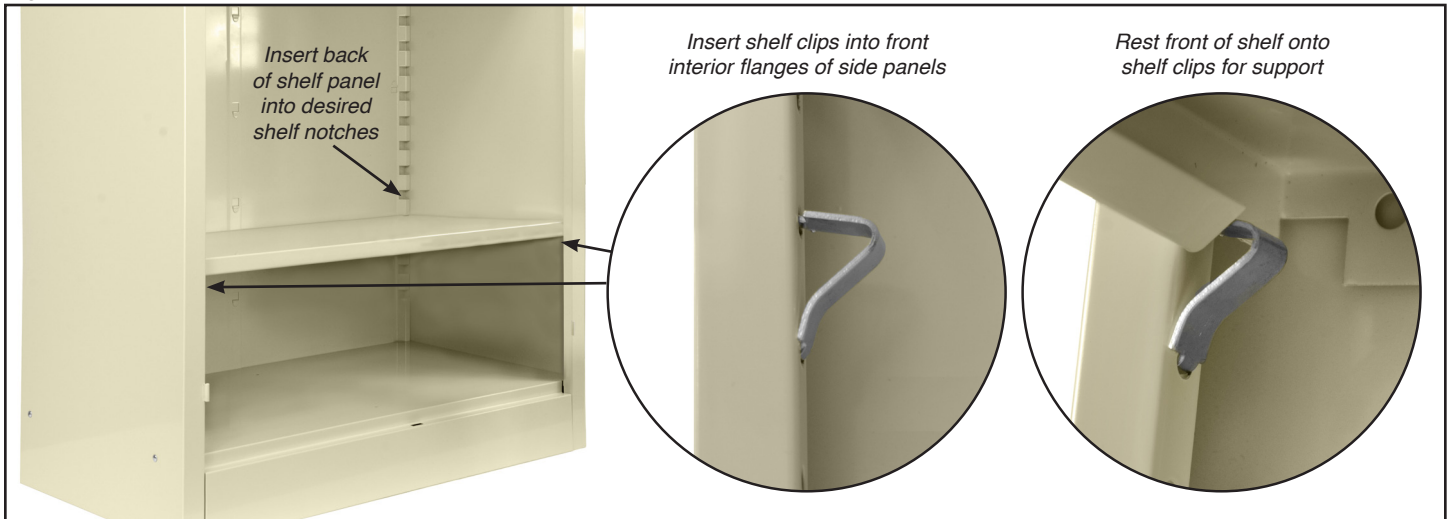

**SALSBURY INDUSTRIES**

Phone: 1-800-562-5377      1010 East 62nd Street, Los Angeles, CA 90001-1598      Int'l Phone: 323-846-6700      Fax: 1-800-562-5399      Int'l Fax: 323-846-6800  
[www.lockers.com](http://www.lockers.com)      [engineering@lockers.com](mailto:engineering@lockers.com)

**STEP 7**

Position left door in place and insert hinge pins into top and bottom door hinges. Repeat this process for the right door. See Figure 7.

Figure 7

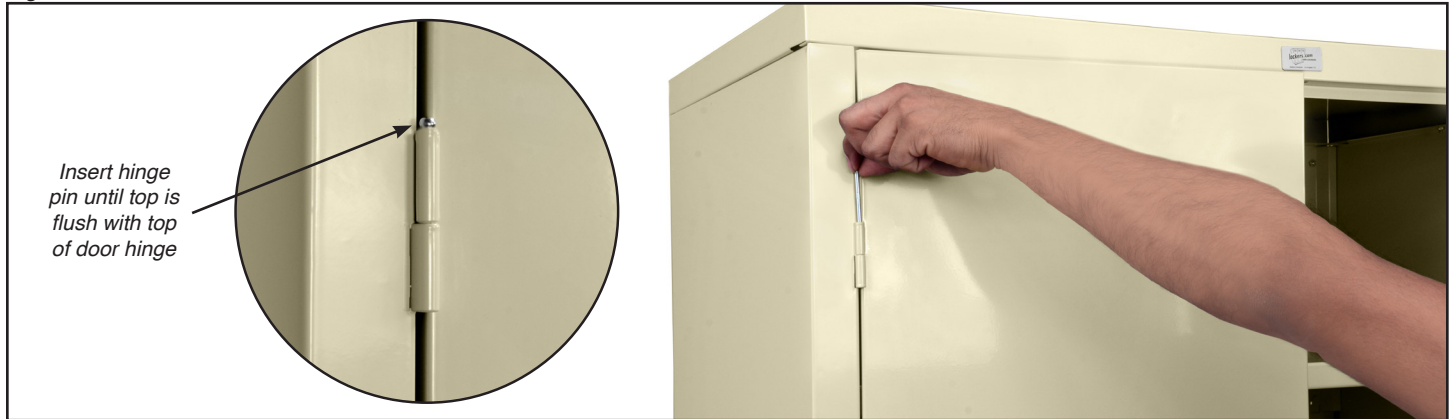

**STEP 8**

Ensure that guides are fully inserted and locked in place. Mount handle on right door with two (2) screws and lockwashers. Insert lock bar guides into slots on top and bottom of right door. Place latch onto the door handle bolt. See Figure 8.

Figure 8



**STEP 9**

Rotate latch to position shown below. Mount lock bars on latch as shown below. Do not fasten latch to handle yet. Rotate handle to open (unlatched position or horizontal) position. Insert lock bars into plastic guides while aligning square hole in latch with square threaded shoulder on handle. Install lock nut on threaded shank of handle. Check that handle, latch, and lock bars operate smoothly and effectively. See Figure 9. This completes the assembly of your storage cabinet.

Figure 9

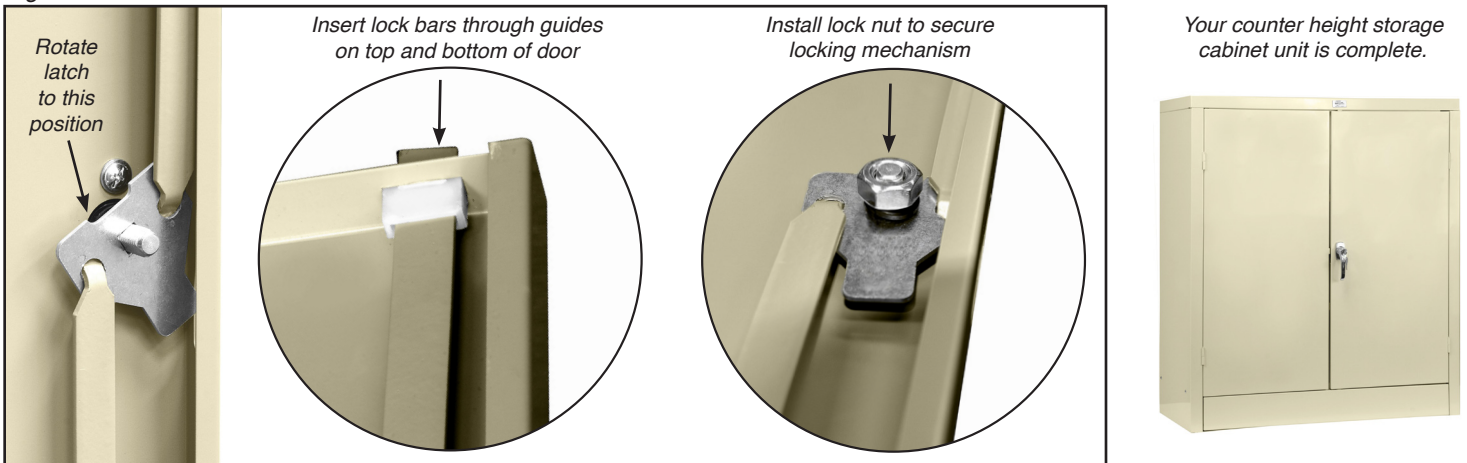

**SALSBURY INDUSTRIES**

Phone: 1-800-562-5377      1010 East 62nd Street, Los Angeles, CA 90001-1598      Int'l Phone: 323-846-6700      Fax: 1-800-562-5399      Int'l Fax: 323-846-6800  
[www.lockers.com](http://www.lockers.com)      [engineering@lockers.com](mailto:engineering@lockers.com)